

MODEL
IHPD7

HEAT PUMP DRYER
7KG

INALT[®]

CLASSIQUE

V 1.0

USER MANUAL

WELCOME

Residentia Group

–

Head Office.

165 Barkly Avenue

Burnley, Victoria

Australia 3121

–

ACN.

600 546 656

–

Online.

residentia.group

Congratulations on purchasing your new appliance. The InAlto brand is proudly distributed within Australia by Residentia Group Pty Ltd.

Please refer to the warranty card at the rear of this manual for information regarding your product's parts and labour warranty, or visit us online at www.residentia.group

At Residentia Group, we are customer obsessed and our Support Team are there to ensure you get the most out of your appliance. Should you want to learn more about the various features of your new appliance, and importantly taking care of your appliance when cleaning, our Support Team are here to help. You can use our online Support Centre at anytime by visiting <http://support.residentiagroup.com.au>, or you can contact us via calling us on 1300 11 HELP (4357).

It is important that you read through the following use and care manual thoroughly to familiarise yourself with the installation and operation requirements of your appliance to ensure optimum performance.

Again, thank you for choosing an InAlto appliance and we look forward to being of service to you.

Kind Regards,
The Residentia Team

Contents

**02
Welcome**

**04
Safety
Instructions**

**06
Installation**

**07
Your InAlto
Dryer**

**08
Quick Start
Guide**

**09
Controls**

**10
Operating
Your Dryer**

**11
Program Table**

**12
Cleaning &
Maintenance**

**14
Troubleshooting**

**15
Technical Data**













**17
Purchase Details**

**18
Warranty
Information**

Safety Instructions

DRY CARE SYMBOLS

Please pay attention to use the drying machine if the materials of your clothes can not be dried by it or contain the symbols as follows:

 Dry	 Normal	 Not tumble dry normal	 Do not dry
 Line dry / hang to dry	 Drip dry	 Dry flat	 In the shade
 Dry clean	 Do not dry clean	 Dry clean normal cycle with any solvent	 Dry clean normal cycle petroleum solvent only

IMPORTANT!

To prevent any damages to your and others' life or property, you have to follow the safety notes.

1. This product belongs to the category of electrical appliances, and only for drying textiles which have been washed with water in the household. Please pay attention to the safety of power use during the operation!
2. The power source with reliable earthing must be used. Its earth wire must be buried under the ground and shall not be connected with the public utilities such as city water pipe or gas pipe etc. The earth wire and null wire shall be distinguished and shall not be connected together.
3. The maximum mass of dry textile material is 7 kilograms to be used in the appliance.
4. That the tumble dryer is not to be used if industrial chemicals have been used for cleaning.
5. Do not dry unwashed items in the tumble dryer.
6. Items that have been soiled with substances such as cooking oil, acetone, alcohol, petrol, kerosene, spot removers, turpentine, waxes and wax removers should be washed in hot water with an extra amount of detergent before being dried in the tumble dryer.
7. Items such as foam rubber (latex foam), shower caps, waterproof textiles, rubber backed articles and clothes or pillows fitted with foam rubber pads should not be dried in the tumble dryer.
8. Fabric softeners, or similar products, should be used as specified by the fabric softener instructions.
9. The final part of a tumble dryer cycle occurs without heat (cool down cycle) to ensure that the items are left at a temperature that ensures that the items will not be damaged.
10. The lint trap has to be cleaned frequently.
11. The lint must not to be allowed to accumulate around the tumble dryer.
12. Adequate ventilation has to be provided to avoid the back flow of gases into the room from appliance burning other fuels, including open fires.

13. **WARNING:** never stop a tumble dryer before the end of the drying cycle unless all items are quickly removed and spread out so that the heat is dissipated.
14. The exhaust air must not be discharged into a flue which is used for exhausting fumes from appliance burning gas or other fuels.
15. The appliance must not be install behind a lockable door, a sliding door or a door with a hinge on the opposite side to that of the tumble dryer. In such a way that a full opening of the tumble dryer door is restricted.
16. Keep pets away from this appliance.
17. Oil-affected items can ignite spontaneously, especially when exposed to heat sources such as in a tumble dryer. The items become warm, causing an oxidation reaction in the oil. Oxidation creates heat. If the heat cannot escape, the items can become hot enough to catch fire. Piling, stacking or storing oil-affected items can prevent heat from escaping and so create a fire hazard.
18. If it is unavoidable that fabrics that contain vegetable or cooking oil or have been contaminated by hair care products be placed in a tumble dryer they should first be washed in hot water with extra detergent-this will reduce, but not eliminate, the hazard.
19. The appliance should not be overturned during normal use or maintenance.
20. Remove all objects from pockets such as lighters and matches.
22. If the power cable is damaged, it must be replaced by the manufacturer, its service agent or similarly qualified persons in order to avoid a hazard.
23. This appliance is for indoor use only.
24. The openings must not be obstructed by a carpet.
25. Children of less than 3 years should be kept away unless continuously supervised. 26. If the appliance appear high temperature abnormally, please draw the mail plug immediately.
26. The appliance is not intended for use by persons (including children) with reduced physical, sensory or mental capabilities, or lack of experience and knowledge, unless they have been given supervision or instruction concerning use of the appliance by a person responsible for their safety. Children should be supervised to ensure that they do not play with the appliance.
27. The power wire shall be met IEC and must be able to withstand the following current:

→ IHPD7 10A

To ensure your and your family's safety, please make improvement immediately if any power use at your home does not meet the above-mentioned requirement.

CORRECT DISPOSAL OF THIS PRODUCT:

This marking indicates that this product should not be disposed with other household wastes throughout the EU. To prevent possible harm to the environment or human health from uncontrolled waste disposal, recycle it responsibly to promote the sustainable reuse of material resources. To return your used device, please use the return and collection systems or contact the retailer where the product was purchased. They can take this product for environmental safe recycling.

ELECTRIC SHOCK HAZARD

1. Do not draw the power cord forcefully to pull out the mains plug.
2. Please do not plug/draw the mains plug with wet hands.
3. Do not damage the power cord and the power plug.

INJURY DANGER

1. Do not disassemble and install the dryer under no instruction or supervision.
2. Do not stack this dryer on washing machine without stacking kits.(if want stacking on washing machine, please purchase the Independent parts and it must be installed by the manufacturer, its service agent or similarly qualified persons in order to avoid a hazard.)
3. Do not lean on the opened door of the dryer.
4. Do not put any pyrotoxin on the dryer, such as the candle, electric cooker.

DAMAGE DANGER

1. Do not dry over the rated capacity.
2. Do not operate the dryer without the filter door and filter base.
3. Do not dry the clothes before being spun.
4. Do not expose the dryer directly under the sun, and indoor use only.
5. Do not install the dryer in the humid and drenching environment.
6. At the cleaning and maintenance, please do remember to pull out the power plug and do not directly wash the dryer with water.

EXPLOSION DANGER

Please do not dry the clothes with some flammable substances such as the coal oil, alcohol or there will be the explosion.

Installation

TRANSPORT

Move cautiously. Do not grasp any salient parts of machine. The machine door can not be used as the handle for delivery. If the dryer can't be transported erect, the dryer could be slant to right less than 30°.

INSTALLATION POSITION

1. It is recommended that, for your convenience, the machine is positioned close to your washing machine.
2. The tumble dryer must be installed in a clean place, where dirt does not build up. Air must be able to circulate freely all round the appliance. Do not obstruct the front air inlet or the air intake grills at the back of the machine.
3. To keep vibration and noise to a minimum when the dryer is in use, it should be placed on a firm and level surface.
4. The feet must never be removed. Do not restrict the floor clearance through deep pile carpets, strips of wood or similar. This might cause heat built-up which would interfere with the operation of the appliance.

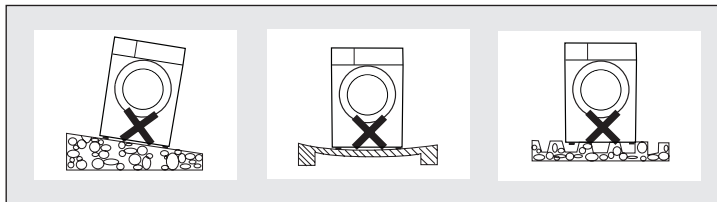

LEVEL ADJUSTING

Once in its permanent operating position, check that the dryer is absolutely level with the aid of a spirit level. If it is not, adjust the feet with a tool.

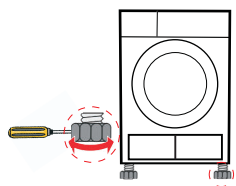

NOTE!

Leave it to stand for 2 hours after transporting. Before first use, please use the soft fabric to clean the inside drum.

1. Put some clean rags into the drum.
2. Plug the power, press On/Off
3. Select the Refresh Program, press Start/Pause button
4. After finishing this program, please follow the "Cleaning And Care" to clean the filter door.

During drying, the compressor and the water pump generate some noise which is entirely normal.

ADVICE

1. Before drying, thoroughly spin the laundry in washing machine. High spin speed can reduce the drying time and save energy consumption.
2. For uniform drying result, sort the laundry according to fabric type and drying program.
3. Before drying, please close zips, hooks and eyelets, button up, tie fabric belts, etc.
4. Do not over dry the clothes, because over dried clothes can easily get creases or shrinkage.
5. Do not dry the articles containing rubber or similar elastic materials such as raincoats, bicycle covers and etc.
6. The door can be opened only after the program of the drying machine is completed. Do not open the door before the program finished, as the skin may be scalded by steam or hot surface.
7. Clean the lint filter and empty container after each use to avoid extension of drying time and energy consumption.
8. Please choose the related program when deal with wool material clothes, to make the cloth more fresh and fluffy.
9. The weight references as follows:

Blended Coats (about 800g)		Jackets (about 800g in cotton)	
Single Sheets (about 600g in cotton)		Work Clothes (upper and lower) (about 1120g in cotton)	
Undershirts (about 180g in cotton)		Underpants (about 70g in cotton)	
Jeans Trousers (about 800g)		Towel Quilts (about 900g in cotton)	
Pajamas (about 200g)		Shirts (about 300g in cotton)	
Socks (about 30g in blended material)			

Your InAlto Dryer

Part Description

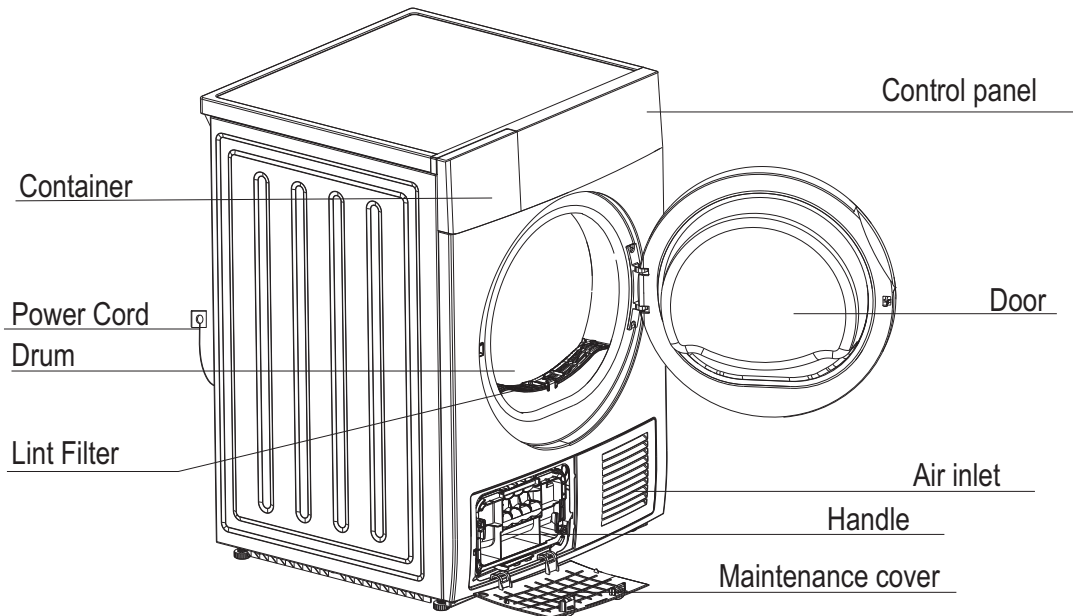

Accessories

The following parts are optional for specific models. If your dryer has following parts, please install them following the instruction below .

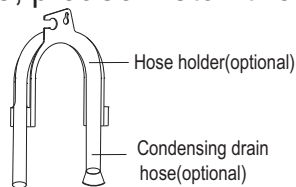

Installation step:

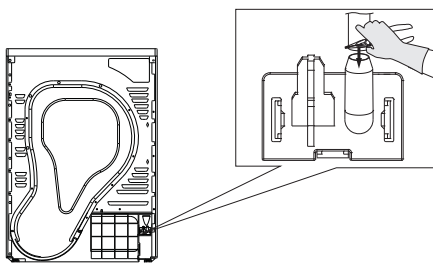

Step 1: removing the drain hose from the hose connector using plier.

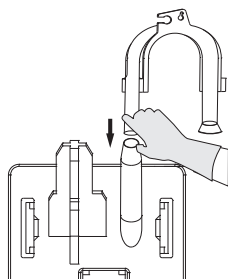

Step 2: insert the external drainage hose.

Step 3: put the hose holder on the washing basin or any other sink.

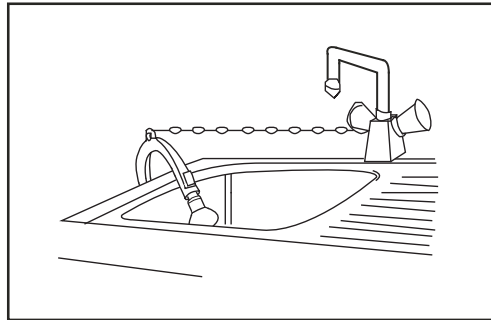
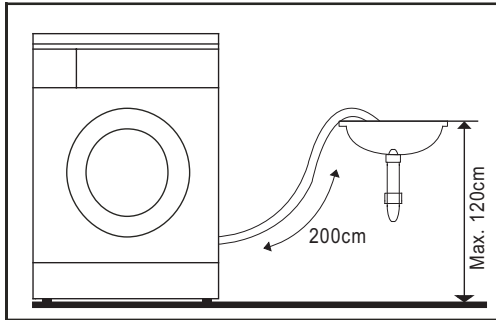

Quick Start Guide

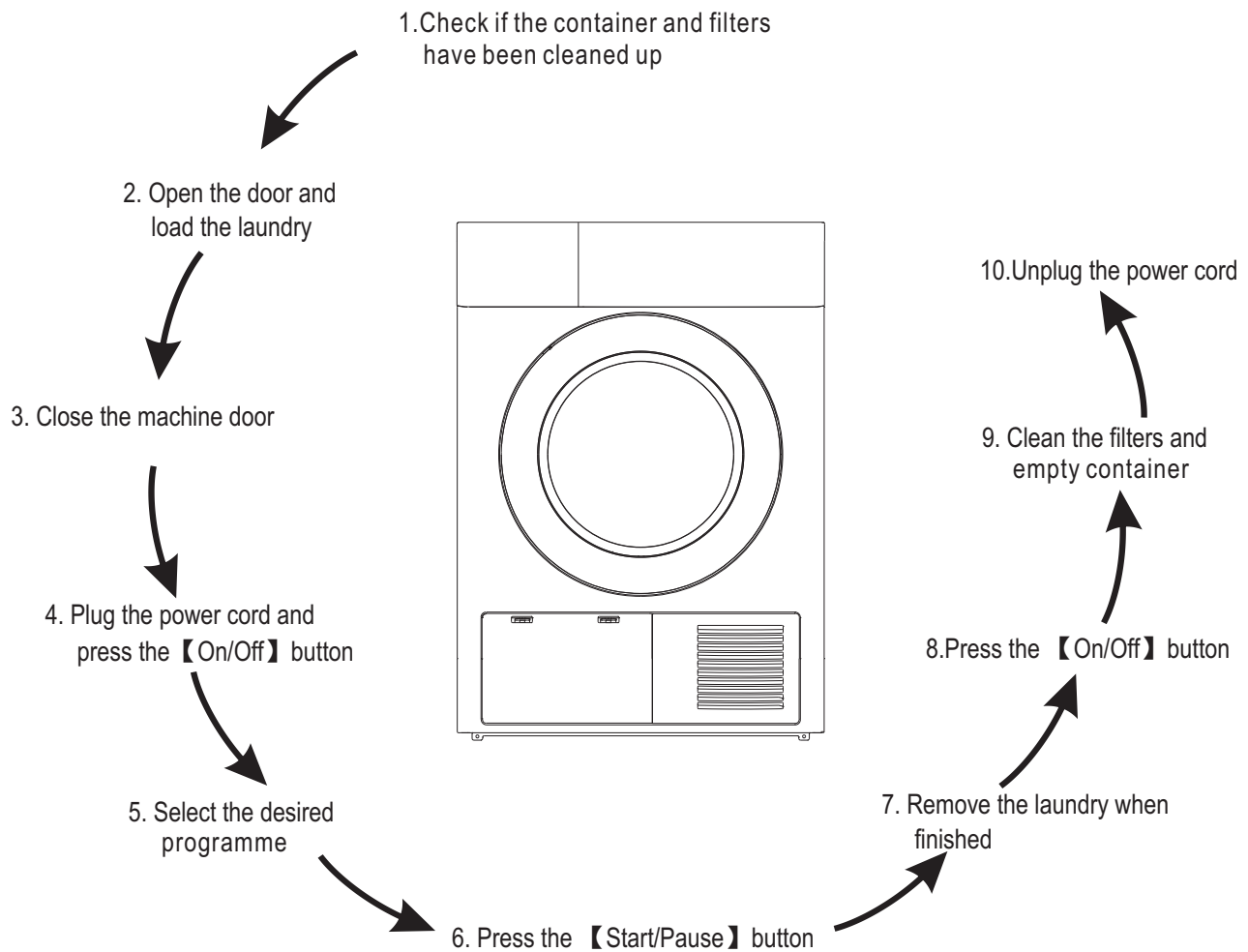

Controls

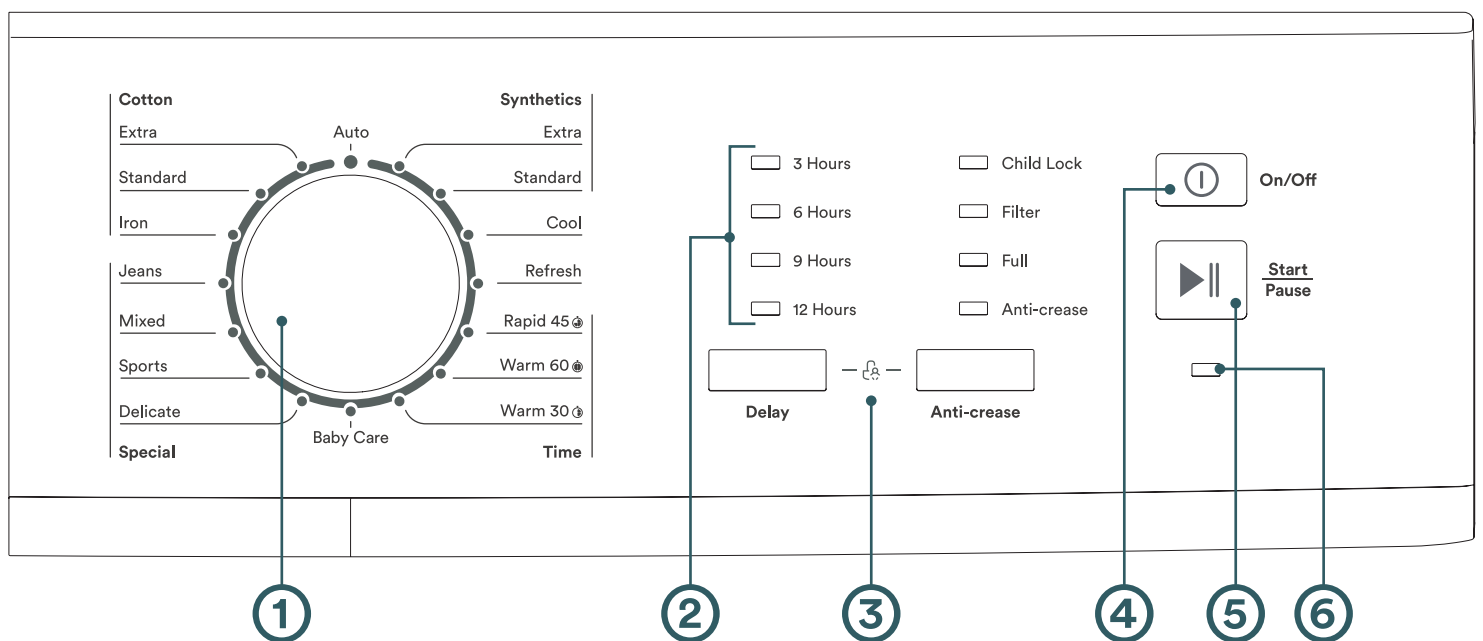

- KEY**
1. PROGRAM SELECTION KNOB
 2. FUNCTION LED:
 - 3H,6H,9H,12H
 - CHILD LOCK
 - FILTER
 - FULL
 - ANTI-CREASE LED
 3. SPECIALTY FUNCTION BUTTONS:
 - DELAY
 - ANTI-CREASE
 - CHILD LOCK
 4. ON/OFF BUTTON
 5. START/PAUSE BUTTON
 6. WORKING STATE LED

Operating Your Dryer

SELECTING THE PROGRAM

1. Press the On/Off button ,when the working state LED brighten up, rotate the program knob to select the desired program.
2. Select the Delay, or Anti-Crease functions for additional option.
3. Press the Start/Pause button.

PROGRAM START

The drum will keep rotating after the program start, the working state LED will flash in sequence.

NOTE:

Occasionally, the drum might pause for approximately 40 seconds during the drying procedure, but the working state LED will flash as per normal. The dryer is automatically adjusting in this time and will continue operation.

PROGRAM END

1. The drum will stop running after the program ends, the working state LED will stay light and buzzer will ring. The “Filter” and “Full” LED will remind user to clean the filters and container. The dryer will start Anti-crease function if user doesn't remove the load in time. Please press On/Off key to cut off power and pull the plug out.
2. Deal with the problem according to “Malfunction display and solutions”, if there is a unexpected stop during the drying procedure and the dryer show information.

SPECIALTY DRYING FUNCTION

DELAY FUNCTION

1. Load your laundry and make sure the machine door is closed.
2. Press the On/Off button,then to turn the program selector knob and select a desired program.
3. You can select the Anti-Crease function according to your need.
4. To press the Delay button.
5. Continue to press the Delay to select the delay time.
6. After the Start/Pause button is pushed, the dryer is at the run condition. The drying procedure will be automatically performed when the delay time is over.
7. If you push the Start/Pause button again, the delay function will be paused.
8. If you want to cancel the “Delay” function, please press the On/Off button.

ANTI-CREASE FUNCTION

At the end of the drying cycle, the anti-crease operation time is 30 minutes (default) or 120 minutes (selected).

The Anti-Crease LED shall light when the anti-crease function is selected. This function prevents the laundry from creases. The laundry can be removed during the anti-crease phase. Except Cool, Refresh, Warm 30' and Warm 60', all the other program have this function.

CHILD LOCK

1. This machine incorporates a special child safety lock, which can prevent children from carelessly pressing buttons or making the faulty operation.
2. When the dryer is at the operation state, press the Anti-Crease and Delay buttons at the same time for over 3 seconds to start child lock function. When child lock function is set, the LED light and no button can effect to the dryer except On/Off button. Under the start state of the child lock, the Anti-Crease and Delay buttons shall be pressed at the same time for over 3 seconds to release the child lock function.

Program Table

Programme		Weight (max)	Application/Properties
Auto	Auto	5.0kg	To dry unknown material clothes automatically.
Cotton	For cottons and coloureds made of cotton or linen.		
	Extra	7.0kg	To dry cotton pieces of clothing. Drying level: extra dry.
	Standard	7.0kg	To dry cotton pieces of clothing. Drying level: cupboard dry.
	Iron	7.0kg	To dry cotton pieces of clothing. Drying level: applicable to iron.
Jeans	Jeans	5.0kg	To dry jeans or leisure clothes that are spun at high speeds in the washing machine.
Mixed	Mixed	3.5kg	If you can not determine what the clothing's material is, please choose Mix.
Sports	Sports	3.0kg	To dry sportswear, thin fabrics, polyester, which are not ironed.
Delicate	Delicate	1.0kg	To dry delicate laundry that is suitable for drying or laundry which is advised to be hand-washed at a lower temperature.
Baby Care	Baby Care	1.0kg	To dry small amount of baby clothing.
Synthetics	For non-iron washing made of synthetic and blended fabrics, cotton.		
	Extra	3.5kg	To dry thick or multi-layered synthetic fabrics. Drying level: extra dry.
	Standard	3.5kg	To dry thin synthetic fabrics which are not ironed, such as easy care shirts, table linen, baby clothes, socks.
Cool	Cool	—	To air clothes without blowing hot air from in 10 min.
Refresh	Refresh	—	To refresh the clothes that have been kept at closed environments for a long time from minimum 20 min. to maximum 150 min. (in 10 min. steps).
Rapid 45'	Rapid 45'	0.6kg	To dry at most 3 shirts in 45 min.
Warm 60'	Warm 60'	—	To warm clothes with hot air in 60 min.
Warm 30'	Warm 30'	—	To warm clothes with hot air in 30 min.

NOTE:

1. Cotton+Extra is for AS/NZS energy program.
2. The programs above are only recommended for using, users can choose the appropriate program according to the personal habits. Thick and multi-layered fabrics, e.g. bedlinen, jeans, jackets etc, are not easy to dry, you'd better choose Jeans program and maximum drying intensity level.
3. As the uneven material, thick and multi-layered clothes are not easy to dry, it is better to choose the appropriate time drying program to dry them if some parts of the clothes still damp after program finished.

Cleaning & Maintenance

Empty the water container

1. Hold and pull out the water container with two hands;
2. Tilt the water container, pour out the condensed water into basin;
3. Install the water container.

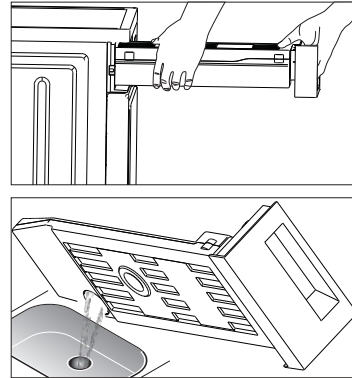

WARNING:

1. Empty the water container after each use, the programme will be paused and the Full LED will light if the water container is full during the drying process. After the container emptied, the dryer can be restarted by pressing **【Start/Pause】** button.
2. Do not drink the condensed water
3. Do not use the dryer without the water container.

Clean the filter door

1. Open the door.
2. Take out the filter door.
3. Clean the filter door; wipe off the scrap threads accumulated on the filter door.
4. Reinstall the filter door.

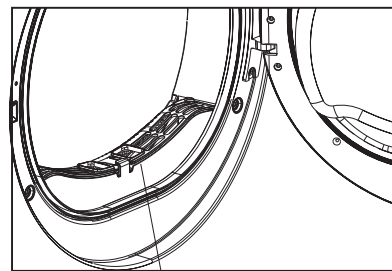

Clean filter base

1. Open the maintenance cover.
2. Unscrew both locking levers towards each other.
3. Clean the filter base completely.
4. Re-insert the filter base!
5. Screw both locking levers.
6. Close the maintenance cover until it locks into position.

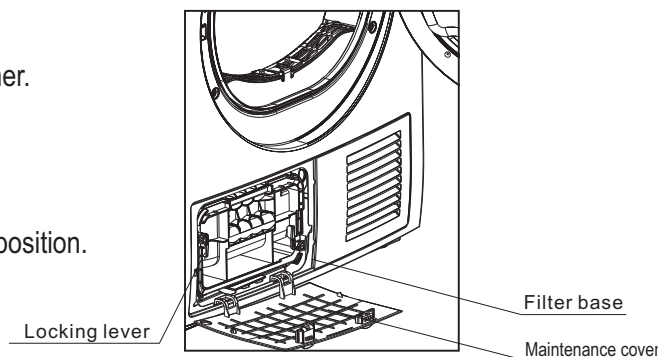

NOTE!

1. The fluff accumulated on the filter will block the air circulation, which will cause the extension of drying time and energy consumption;
2. Do not disconnect the power cord before cleaning!
3. Do not operate the dryer without the filter!
4. Clean the filter after each use to prevent lint accumulation inside the dryer.

Clean heat exchanger

As necessary, approx. once every 2 months, remove the fluff from the heat exchanger using the sponge or soft brush.

When doing this, please use gloves.

Note: The fluff can be removed more easily if it is first dampened e. g. with a laundry dampener.

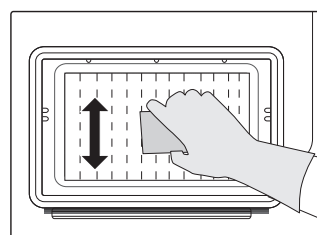

This page
is intentionally
left blank

Troubleshooting

Please read the issues below carefully and try all relevant steps.
If none of this helps, please contact us on 1300 11 4357 for further advice or to schedule a technician to inspect your dryer.

Display	Reason	Solutions
"Full" LED on permanently	Container is full	Empty container
	Water pump failure or water level sensor failure	Please contact your local service center if the problem persists
Child Lock + 9h	Temperature sensor failure	
Child Lock + 6h	Humidity sensor failure	
Child Lock + 3h (Only MDS70-C05/B08-AU(2))	Heater failure	

Problem	Solution
•Working state LED not on	<ul style="list-style-type: none"> •The mains plug is inserted. •Check the programme selected. •Check fuse in the house.
• "Full"LED on permanently	<ul style="list-style-type: none"> •Empty condensation container. •If failure, check hose for condensation outlet.
•Dryer does not start	<ul style="list-style-type: none"> •Check the start button has selected . •Check the the door has closed. •Check the programme has set.
•Water is running out	<ul style="list-style-type: none"> •Align dryer horizontally. •Clear air condenser and door seals.
•Door is open by itself	<ul style="list-style-type: none"> •Press door until it "clicks"into position. •Check the clothes is over load .
•Humidity in the room is increase significantly	<ul style="list-style-type: none"> •Ventilate room adequately. •Clean the cool grille. •Ensure that the air condenser has been inserted.
•Degree of dryness was not reached or drying time too long	<ul style="list-style-type: none"> •Clean lint filter and wash condenser. •Empty container. •Check water outlet. •Dryer installation too restricted. •Clean the moisture sensors. •Use next higher drying programme or using Timer programme.

Technical Data

Parameter \ Model	IHPD7
Dimension(L*W*H)	622*595*845(mm)
Ambient temperature	+5°C ~ +35°C
Rated input power	850W
Rated voltage	220-240V~
Rated frequency	50Hz
Refrigerant	R134a
Weight of product	51kg
Rated capacity	7.0kg

Contains fluorinated greenhouse gases covered by the Kyoto Protocol.
Hermetically sealed.

Note:

1. The rated capacity is the maximum capacity, make sure that the dry clothes which are loaded to the appliance do not exceed the rated capacity each time.
2. Do not install the tumble dryer in a room when there is a risk of frost occurring. At temperatures around freezing point the tumble dryer may not be able to operate properly.
3. There is a risk of damage if the condensed water is allowed to freeze in the pump, hoses and / or condensed water container.

Attach your receipt
to this page



Purchase Details

For future reference, please record the following information which can be found on the rating plate and the date of purchase which can be found on your sales invoice.

The rating plate of your hob is located on the underneath of the appliance. Therefore please fit the duplicate data plates or label on the outside of the cupboard to sure that the label can be easily seen during operation.

STORE DETAILS

STORE NAME | _____

ADDRESS | _____

TELEPHONE | _____ PURCHASE DATE | _____

PRODUCT DETAILS

MODEL NO. | _____

SERIAL NO.* | _____

Warranty Information

WARRANTY TERMS & CONDITIONS CLOTHES DRYERS

This document sets out the terms and conditions of the product warranties for Residentia Group Appliances. It is an important document. Please keep it with your proof of purchase documents in a safe place for future reference should you require service for your Appliance.

1. **IN THIS WARRANTY**
 - (a) 'acceptable quality' as referred to in clause 10 of this warranty has the same meaning referred to in the ACL;
 - (b) 'ACL' means Trade Practices Amendment (Australian Consumer Law) Act (No.2) 2010;
 - (c) 'Appliance' means any Residentia Group product purchased by you accompanied by this document;
 - (d) 'ASR' means Residentia Group authorised service representative;
 - (e) 'Residentia Group' means Residentia Group Pty Ltd of 165 Barkly Ave, Burnley VIC 3121, ACN 600 546 656 in respect of Appliances purchased in Australia;
 - (f) 'major failure' as referred to in clause 10 of this warranty has the same meaning referred to in the ACL and includes a situation when an Appliance cannot be repaired or it is uneconomic for Residentia Group, at its discretion, to repair an Appliance during the Warranty Period;
 - (g) 'Warranty Period' means:
 - (i) where the Appliance is used for personal, domestic or household use (i.e. normal single family use) as set out in the instruction manual, the Appliance is warranted against manufacturing defects for 24 months, following the date of original purchase of the Appliance;
 - (h) 'you' means the purchaser of the Appliance not having purchased the Appliance for re-sale, and 'your' has a corresponding meaning.
2. This warranty only applies to Appliances purchased and used in Australia and is in addition to (and does not exclude, restrict, or modify in any way) any non-excludable statutory warranties in Australia.
3. During the Warranty Period Residentia Group or its ASR will, at no extra charge if your Appliance is readily accessible for service, without special equipment and subject to these terms and conditions, repair or replace any parts which it considers to be defective. Residentia Group or its ASR may use remanufactured parts to repair your Appliance. You agree that any replaced Appliances or parts become the property of Residentia Group. This warranty does not apply to light globes, batteries, filters or similar perishable parts.
4. Parts and Appliances not supplied by Residentia Group are not covered by this warranty.

-
5. You will bear the cost of transportation, travel and delivery of the Appliance to and from Residentia Group or its ASR. If you reside outside of the service area, you will bear the cost of:
- (a) travel of an authorised representative;
 - (b) transportation and delivery of the Appliance to and from Residentia Group or its ASR, in all instances, unless the Appliance is transported by Residentia Group or its ASR, the Appliance is transported at the owner's cost and risk while in transit to and from Residentia Group or its ASR.
6. Proof of purchase is required before you can make a claim under this warranty.
7. You may not make a claim under this warranty unless the defect claimed is due to faulty or defective parts or workmanship. Residentia Group is not liable in the following situations (which are not exhaustive):
- (a) the Appliance is damaged by:
 - (i) accident
 - (ii) misuse or abuse, including failure to properly maintain or service
 - (iii) normal wear and tear
 - (iv) power surges, electrical storm damage or incorrect power supply
 - (v) incomplete or improper installation
 - (vi) incorrect, improper or inappropriate operation
 - (vii) insect or vermin infestation
 - (viii) failure to comply with any additional instructions supplied with the Appliance;
 - (b) the Appliance is modified without authority from Residentia Group in writing;
 - (c) the Appliance's serial number or warranty seal has been removed or defaced;
 - (d) the Appliance was serviced or repaired by anyone other than Residentia Group, an authorised repairer or ASR.
8. This warranty, the contract to which it relates and the relationship between you and Residentia Group are governed by the law applicable where the Appliance was purchased.
9. To the extent permitted by law, Residentia Group excludes all warranties and liabilities (other than as contained in this document) including liability for any loss or damage whether direct or indirect arising from your purchase, use or non use of the Appliance.
10. For Appliances and services provided by Residentia Group in Australia, the Appliances come with a guarantee by Residentia Group that cannot be excluded under the Australian Consumer Law. You are entitled to a replacement or refund for a major failure and for compensation for any other reasonably foreseeable loss or damage. You are also entitled to have the Appliance repaired or replaced if the Appliance fails to be of acceptable quality and the failure does not amount to a major failure. The benefits to you given by this warranty are in addition to your other rights and remedies under a law in relation to the Appliances or services to which the warranty relates.
11. At all times during the Warranty Period, Residentia Group shall, at its discretion, determine whether repair, replacement or refund will apply if an Appliance has a valid warranty claim applicable to it.
12. To enquire about claiming under this warranty, please follow these steps:
- (a) carefully check the operating instructions, user manual and the terms of this warranty;
 - (b) have the model and serial number of the Appliance available;
 - (c) have the proof of purchase (e.g. an invoice) available;
 - (d) telephone the numbers shown below.
13. You accept that if you make a warranty claim, Residentia Group and its ASR may exchange information in relation to you to enable Residentia Group to meet its obligations under this warranty.

IMPORTANT

Before calling for service, please ensure that the steps in point 12 have been followed.

→ Service: Please call 1300 11 HELP (4357)

The Australian Consumer Law requires the inclusion of the following statement with this warranty: Our goods come with guarantees that cannot be excluded under the Australian Consumer Law. You are entitled to a replacement or refund for a major failure and for compensation for any other reasonably foreseeable loss or damage. You are also entitled to have the goods repaired or replaced if the goods fail to be of acceptable quality and the failure does not amount to a major failure.

AN INITIATIVE BY

RESIDENTIA GROUP

INALT[®] CLASSIQUE



E2447

TEL. 1300 11 4357
SUPPORT@RESIDENTIAGROUP.COM.AU
WWW.RESIDENTIA.GROUP